

24V AC, 600W outdoor & indoor magnetic transformer.

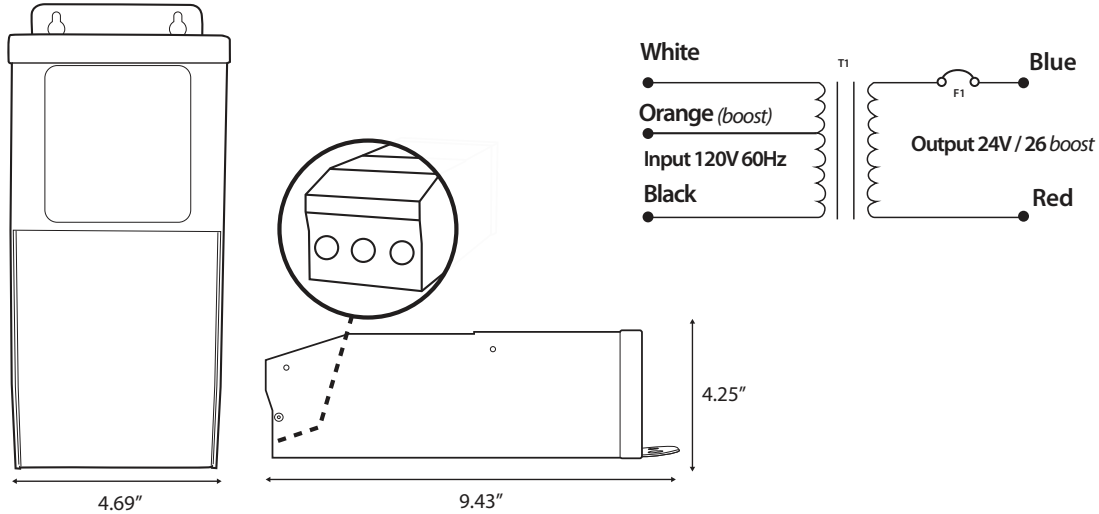

Features

- Manual reset thermal circuit breaker on the secondary side.
- Dimmable with any standard MLV TRIAC dimmer.
- cULus and cETLus listed
- NEMA 3R enclosure

Specifications

Max Load	600W
Input Voltage	120V AC
Input Current Full Load	5.1 A
Output Voltage Full Load	23V AC
Max Output Current Full Load	22 A
Open Circuit Output Voltage	23V AC
Efficiency	93%
Max. Ambient Temperature	-30°C to 50°C
Min. Installation Space Between Drivers	5"
Thermal Class	B130°C
Leads Primary	PVC 600V #18
Leads Secondary	PVC 300V #12
Dimensions L*W*H	9.43 in. x 4.69 in. x 4.25 in. (239.52 mm x 119.12 mm x 107.95 mm)
Weight	16 lbs.

Ordering Code

TR - 24 - 600

Project		Type	
Date		Contact	
Notes			