

# LED TAPE LIGHT

## High Power Indoor



Suitable for high ceiling coves or areas that require higher illumination. Commercial, retail, hospitality and residential applications.



### HIGH POWER SINGLE COLOR LTP-20 SERIES

#### FEATURES

- 1 Bin
- 2 Step MacAdam Ellipse
- 3oz PCB board
- 3M Adhesive
- 50,000 hours life
- High brightness 5060 SMD LEDs
- Field cuttable
- Low power consumption
- Available in 20' (6.1m) and 100' (30.48m) spools (custom cuts available)
- Safe, 24V class 2 power supplies (sold separately)
- Fully dimmable with dimmable power supplies (sold separately)
- 20' spools come with 6 ft. pre-soldered power feeds
- 6 year limited warranty

#### APPLICATIONS

- Aisle and stairway lighting
- Cabinet and cove lighting
- Back lighting
- Showcase lighting
- Linear decorative lighting

#### PRODUCT CODES

20Ft spools  
LTP - 20 - **YY** - H90

- LED COLOR**
- 2700K
  - 3000K
  - 3500K
  - 4000K
  - 6500K

100Ft spools  
LTP - 100 - **YY** - H90

- LED COLOR**
- 2700K
  - 3000K
  - 3500K
  - 4000K
  - 6500K

Custom cuts  
LTP - XX - **YY** - H90

- LED COLOR**
- 2700K
  - 3000K
  - 3500K
  - 4000K
  - 6500K

LTP - 20 - **YY**

**LED COLOR**

- RD** - Red
- AM** - Amber
- GR** - Green
- BL** - Blue

LTP - 100 - **YY**

**LED COLOR**

- RD** - Red
- AM** - Amber
- GR** - Green
- BL** - Blue

LTP - XX - **YY**

**LED COLOR**

- RD** - Red
- AM** - Amber
- GR** - Green
- BL** - Blue

#### SPECIFICATIONS

Electrical	24V DC, 4.3W/ft
LED Type	High Brightness 5060 SMD LEDs
Viewing Angle	120°
LED Life	50,000 hours to 70% initial lumen output
LED Spacing	16mm (0.63")
# of LEDs per foot (304mm)	18
Maximum Single Run	20'
Lumen Output	325 Lumens per ft 6500K 300 Lumens per ft 4000K 293 Lumens per ft 3500K 285 Lumens per ft 3000K 280 Lumens per ft 2700K
Efficacy	75 LPW 6500K, 70 LPW 4000K, 68 LPW 3500K, 66 LPW 3000K, 65 LPW 2700K
Custom Cuttable	1.3" (33mm)
Color Temperature	2700K, 3000K, 3500K, 4000K, 6500K
CRI	> 90 for white color temperatures
Approvals	cETLus

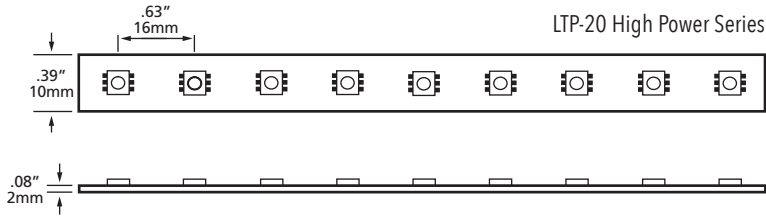

## ACCESSORIES



**LTP-001-6R**  
72" Power feed connector for single color indoor. Add "-L" to code for opposite end, add "-CM" for through wall connections.

**LTP-001-12R**  
**LTP-001-12L**  
12FT Power Feed Connector



**LTP-002**  
In-line connector for single color indoor



**LTP-STP-6IN**  
5.9" (15cm)  
**LTP-STP-2IN**  
2" (5cm)  
**LTP-STP-2**  
2' (61cm)  
**LTP-STP-12**  
12' (3.65m)  
In-line connector for single color indoor



**LTP-003-6DC**  
DC connector for LED Tape Light with 6" wire and DC connector



**LMSII-001**  
Terminal block and junction box for connection to additional lengths of power cable if needed

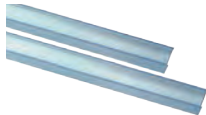

**LTP-010-S**  
Clear PVC mounting "U" channel



**LV-SPIR-1CH-LV**  
PIR Motion Sensor, 1 Channel, 24V DC  
NOTE: To be used with non dimmable drivers only

**NOTE: See page 34-35 for the complete range of aluminum extrusions.**

## INDOOR/OUTDOOR DIMMABLE DRIVERS

### TRE24L40DC

Max recommended load 36W or 8' LED Tape,  
min 8W or 2' LED Tape  
6.77" x 2.67" x 1.26" (171 x 68 x 32mm)

### TRE24L96DC

Max recommended load 90W or 20' LED Tape,  
min 8W or 2' LED Tape  
6.77" x 2.67" x 1.26" (171 x 68 x 32mm)

## NON DIMMABLE DRIVERS

### LEDDR-24-120W

Indoor/Outdoor driver  
Max. recommended load 90W or 20' (6.1m) per single tap,  
120W or 27' (8.23m) combined two secondary taps.  
120W hardwire  
Input: 100 - 240V AC  
Output: 24V DC  
10" x 3 3/8" x 3 3/16" (254 x 85.7 x 80.9mm)

## NON DIMMABLE PLUG IN DRIVERS

**LMS-24-18W**  
**LMS-24-60W**

# LED TAPE LIGHT

## Low Power Indoor



Great choice for under cabinet and coves offering subtle lighting effects.



### LOW POWER SINGLE COLOR LTP-20-LP SERIES

#### FEATURES

- 1 Bin
- 2 Step MacAdam Ellipse
- 3oz PCB board
- 3M Adhesive
- 50,000 hours life
- High brightness 5060 SMD LEDs
- Field cuttable
- Low power consumption
- Available in 20' (6.1m) and 100' (30.48m) spools (custom cuts available)
- Safe, 24V class 2 power supplies (sold separately)
- Fully dimmable with dimmable power supplies (sold separately)
- 20' spools come with 6 ft. pre-soldered power feeds
- 6 year limited warranty

#### APPLICATIONS

- Aisle and stairway lighting
- Cabinet and cove lighting
- Back lighting
- Showcase lighting
- Linear decorative lighting

#### PRODUCT CODES

20Ft spools  
LTP - 20 - **YY** - H90 - LP

**LED COLOR**

- 2700K
- 3000K
- 3500K
- 4000K
- 6500K

LTP - 20 - **YY** - LP

**LED COLOR**

- RD** - Red
- AM** - Amber
- GR** - Green
- BL** - Blue

100Ft spools  
LTP - 100 - **YY** - H90 - LP

**LED COLOR**

- 2700K
- 3000K
- 3500K
- 4000K
- 6500K

LTP - 100 - **YY** - LP

**LED COLOR**

- RD** - Red
- AM** - Amber
- GR** - Green
- BL** - Blue

Custom cuts  
LTP - **XX** - **YY** - H90 - LP

**LED COLOR**

- 2700K
- 3000K
- 3500K
- 4000K
- 6500K

LTP - **XX** - **YY** - LP

**LED COLOR**

- RD** - Red
- AM** - Amber
- GR** - Green
- BL** - Blue

#### SPECIFICATIONS

Electrical	24V DC, 2.2W/ft
LED Type	High Brightness 5060 SMD LEDs
Viewing Angle	120°
LED Life	50,000 hours to 70% initial lumen output
LED Spacing	32mm (1.26")
# of LEDs per foot (304mm)	9
Maximum Single Run	40'
Lumen Output	165 Lumens per ft 6500K 150 Lumens per ft 4000K 148 Lumens per ft 3500K 145 Lumens per ft 3000K 143 Lumens per ft 2700K
Efficacy	75 LPW 6500K, 68 LPW 4000K, 67 LPW 3500K, 66 LPW 3000K, 65 LPW 2700K
Custom Cuttable	6.5"
Color Temperature	2700K, 3000K, 3500K, 4000K, 6500K
CRI	> 90 for white color temperatures
Approvals	cETLus

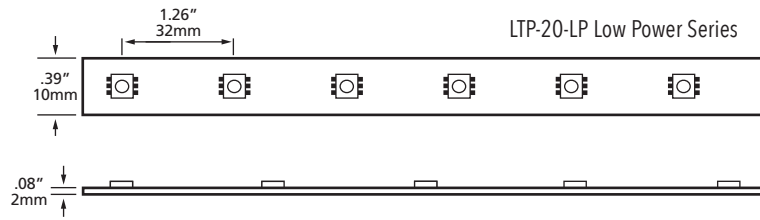

## ACCESSORIES



**LTP-001-6R**  
72" Power feed connector for single color indoor. Add "-L" to code for opposite end, add "-CM" for through wall connections.

**LTP-001-12R**

**LTP-001-12L**

12FT Power Feed Connector



**LTP-002**

In-line connector for single color indoor



**LTP-STP-6IN**

5.9" (15cm)

**LTP-STP-2IN**

2" (5cm)

**LTP-STP-2**

2' (61cm)

**LTP-STP-12**

12' (3.65m)

In-line connector for single color indoor



**LTP-003-6DC**

DC connector for LED Tape Light with 6" wire and DC connector



**LMSII-001**

Terminal block and junction box for connection to additional lengths of power cable if needed

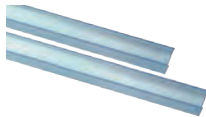

**LTP-010-S**

Clear PVC mounting "U" channel



**LV-SPIR-1CH-LV**

PIR Motion Sensor, 1 Channel, 24V DC  
NOTE: To be used with non dimmable drivers only

**NOTE: See page 34-35 for the complete range of aluminum extrusions.**

## INDOOR/OUTDOOR DIMMABLE DRIVERS

**TRE24L40DC**

Max recommended load 36W or 16' LED Tape,  
min 8W or 4' LED Tape  
6.77" x 2.67" x 1.26" (171 x 68 x 32mm)

**TRE24L96DC**

Max recommended load 90W or 40' LED Tape,  
min 8W or 4' LED Tape  
6.77" x 2.67" x 1.26" (171 x 68 x 32mm)

## NON DIMMABLE DRIVERS

**LEDDR-24-120W**

Indoor/Outdoor driver  
Max. recommended load 90W or 40' (12.1m) per single tap,  
120W or 54' (16.46m) combined two secondary taps.  
120W hardware  
Input: 100 - 240V AC  
Output: 24V DC  
10" x 3 3/8" x 3 3/16" (254 x 85.7 x 80.9mm)

## NON DIMMABLE PLUG IN DRIVERS

**LMS-24-18W**

**LMS-24-60W**

# HIGH DENSITY LED TAPE LIGHT

## High Power Indoor

Ideal for display cabinets needing high illumination. Can be used as a wall grazer offering great vertical illumination.



## HIGH DENSITY SINGLE COLOR LTP-HD SERIES



### FEATURES

- 1 Bin
- 2 Step MacAdam Ellipse
- 3oz PCB board
- 3M Adhesive
- 50,000 hours life
- High brightness 3528 Epistar LEDs
- Field cuttable
- Low power consumption
- Available in 16' (5m) and 100' (30.48m) spools (custom cuts available)
- 16' spools come with 6Ft pre-soldered power feeds
- Safe, 24V class 2 power supplies (sold separately)
- Fully dimmable with dimmable power supplies (sold separately)
- 6 year limited warranty

### APPLICATIONS

- Aisle and stairway lighting
- Cabinet and cove lighting
- Back lighting
- Showcase lighting
- Linear decorative lighting

### SPECIFICATIONS

Electrical	24V DC, 5.8 W/ft
LED Type	High Brightness 3528 Epistar LEDs
Viewing Angle	120°
LED Life	50,000 hours to 70% initial lumen output
LED Spacing	4.2mm (0.17")
# of LEDs per foot (304mm)	72
Maximum Single Run	16'
Custom Cuttable	1" (25mm)
Lumen Output	514 Lumens per ft 6500K 468 Lumens per ft 4000K 450 Lumens per ft 3000K
Efficacy	88 LPW 6500K, 80 LPW 4000K, 77 LPW 3000K
Color Temperature	3000K, 4000K, 6500K
CRI	> 90
Approvals	cETLus

### PRODUCT CODES

16Ft spools  
LTP - 16 - **YY** - HD - H90

**LED COLOR**  
3000K  
4000K  
6500K

100Ft spools  
LTP - 100 - **YY** - HD - H90

**LED COLOR**  
3000K  
4000K  
6500K

Custom cuts  
LTP - **XX** - **YY** - HD - H90

**LED COLOR**  
3000K  
4000K  
6500K

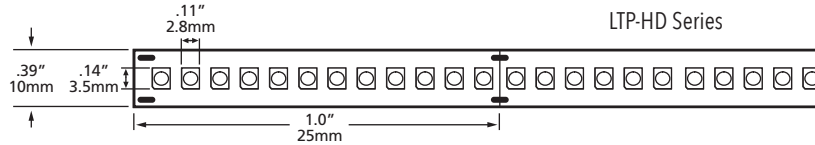

## ACCESSORIES

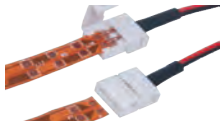

**LTP-001-HD-HP-6**  
72" Power feed connector for high density indoor



**LMSII-001**  
Terminal block and junction box for connection to additional lengths of power cable if needed

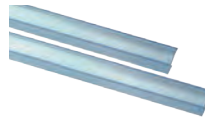

**LTP-010-S**  
Clear PVC mounting "U" channel



**LV-SPIR-1CH-LV**  
PIR Motion Sensor, 1 Channel, 24V DC  
NOTE: To be used with non dimmable drivers only

**NOTE: See page 34-35 for the complete range of aluminum extrusions.**

## INDOOR/OUTDOOR DIMMABLE DRIVERS

### TRE24L40DC

Max recommended load 36W or 6' LED Tape,  
min 8W or 2' LED Tape  
6.77" x 2.67" x 1.26" (171 x 68 x 32mm)

### TRE24L96DC

Max recommended load 90W or 16' LED Tape,  
min 8W or 2' LED Tape  
6.77" x 2.67" x 1.26" (171 x 68 x 32mm)

## NON DIMMABLE DRIVERS

### LEDDR-24-120W

Indoor/Outdoor driver  
Max. recommended load 90W or 16' (4.8m) per single tap,  
120W or 20' (6.1m) combined two secondary taps.  
120W hardwire  
Input: 100 - 240V AC  
Output: 24V DC  
10" x 3 3/8" x 3 3/16" (254 x 85.7 x 80.9mm)

# HIGH DENSITY LED TAPE LIGHT

## Low Power Indoor

Suitable for display cabinets and applications needing lower but even illumination.



### HIGH DENSITY SINGLE COLOR LTP-HD-LP SERIES



#### FEATURES

- 1 Bin
- 2 Step MacAdam Ellipse
- 3oz PCB board
- 3M Adhesive
- 50,000 hours life
- High brightness 3528 Epistar LEDs
- Field cuttable
- Low power consumption
- Available in 16' (5m) and 100' (30.48m) spools (custom cuts available)
- 16' spools come with 6Ft pre-soldered power feeds
- Safe, 24V class 2 power supplies (sold separately)
- Fully dimmable with dimmable power supplies (sold separately)
- 6 year limited warranty

#### APPLICATIONS

- Aisle and stairway lighting
- Cabinet and cove lighting
- Back lighting
- Showcase lighting
- Linear decorative lighting

#### SPECIFICATIONS

Electrical	24V DC, 2.9 W/ft
LED Type	High Brightness 3528 Epistar LEDs
Viewing Angle	120°
LED Life	50,000 hours to 70% initial lumen output
LED Spacing	8.3mm (0.33")
# of LEDs per foot (304mm)	36
Maximum Single Run	31'
Custom Cuttable	2" (50mm)
Lumen Output	257 Lumens per ft 6500K 234 Lumens per ft 4000K 225 Lumens per ft 3000K
Efficacy	88 LPW 6500K, 80 LPW 4000K, 77 LPW 3000K
Color Temperature	3000K, 4000K, 6500K
CRI	> 90
Approvals	cETLus

#### PRODUCT CODES

16Ft spools  
LTP - 16 - **YY** - HD - LP - H90

LED COLOR  
3000K  
4000K  
6500K

100Ft spools  
LTP - 100 - **YY** - HD - LP - H90

LED COLOR  
3000K  
4000K  
6500K

Custom cuts  
LTP - **XX** - **YY** - HD - LP - H90

LED COLOR  
3000K  
4000K  
6500K

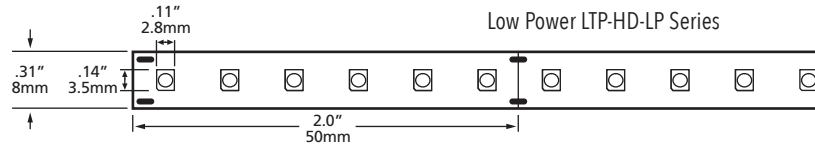

## ACCESSORIES

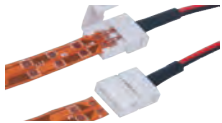

**LTP-001-HD-6**  
72" Power feed connector for high density indoor.



**LTP-002-HD**  
In-line connector for high density indoor



**LTP-STP-HD-6IN**  
6" In-line connector for high density indoor



**LMSII-001**  
Terminal block and junction box for connection to additional lengths of power cable if needed

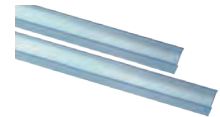

**LTP-010-S**  
Clear PVC mounting "U" channel



**LV-SPIR-1CH-LV**  
PIR Motion Sensor, 1 Channel, 24V DC  
NOTE: To be used with non dimmable drivers only

**NOTE: See page 34-35 for the complete range of aluminum extrusions.**

## INDOOR/OUTDOOR DIMMABLE DRIVERS

### TRE24L40DC

Max recommended load 36W or 12' LED Tape,  
min 8W or 3' LED Tape  
6.77" x 2.67" x 1.26" (171 x 68 x 32mm)

### TRE24L96DC

Max recommended load 90W or 31' LED Tape,  
min 8W or 3' LED Tape  
6.77" x 2.67" x 1.26" (171 x 68 x 32mm)

## NON DIMMABLE DRIVERS

### LEDDR-24-120W

Indoor/Outdoor driver  
Max. recommended load 90W or 31' (9.4m) per single tap,  
120W or 41' (12.5m) combined two secondary taps.  
120W hardwire  
Input: 100 - 240V AC  
Output: 24V DC  
10" x 3 3/8" x 3 3/16" (254 x 85.7 x 80.9mm)



# LED TAPE LIGHT

## High Efficacy, Indoor

Our highest lumen output for those applications needing high illumination and great color rendering.



### FEATURES

- 1 Bin
- 2 Step MacAdam Ellipse
- 3oz PCB board
- 3M Adhesive
- 50,000 hours life
- Field cuttable every 1.3"
- Low power consumption
- Available in 16' (5m) and 100' (30.48m) spools (custom cuts available)
- 16' spools come with 6Ft pre-soldered power feeds
- Safe, 24V DC operation
- Fully dimmable with dimmable power supplies (sold separately)
- 6 years limited warranty

### APPLICATIONS

- Aisle and stairway lighting
- Cabinet and cove lighting
- Back lighting
- Showcase lighting
- Linear decorative lighting

### SPECIFICATIONS

Electrical	24V DC, 5.1W/FT
LED Type	High Brightness 2835 LEDs
Viewing Angle	120°
LED Life	50,000 hours
LED Spacing	4mm (0.16")
# of LEDs per foot	73
Maximum single run	16'
Custom cuttable	33mm (1.3")
Lumen Output	586 Lumens per ft 6500K 540 Lumens per ft 4000K 527 Lumens per ft 3500K 513 Lumens per ft 3000K 508 Lumens per ft 2700K
Efficacy	115 LPW 6500K, 106 LPW 4000K, 103 LPW 3500K, 100LPW 3000K, 99 LPW 2700K
Color Temperature	2700K, 3000K, 3500K, 4000K, 6500K
CRI	>90
Approvals	cETLus

### PRODUCT CODES

16Ft spools

**LTP - 16 - YY - HE - H90**

**LED Tape Light  
High Efficacy,  
Indoor**

**LED COLOR**  
2700K  
3000K  
3500K  
4000K  
6500K

100Ft spools

**LTP - 100 - YY - HE - H90**

**LED Tape Light  
High Efficacy,  
Indoor**

**LED COLOR**  
2700K  
3000K  
3500K  
4000K  
6500K

Custom cuts

**LTP - XX - YY - HE - H90**

**LED Tape Light  
High Efficacy,  
Indoor**

**LED COLOR**  
2700K  
3000K  
3500K  
4000K  
6500K

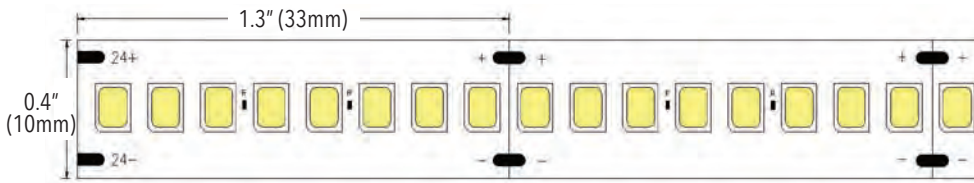

## ACCESSORIES



**LTP-001-HD-HP-6**  
72" Power feed connector  
for high density indoor



**LMSII-001**  
Terminal block and junction  
box for connection to  
additional lengths of power  
cable if needed

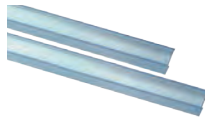

**LTP-010-S**  
Clear PVC mounting  
"U" channel



**LV-SPIR-1CH-LV**  
PIR Motion Sensor, 1  
Channel, 24V DC  
NOTE: To be used with non  
dimable drivers only

**NOTE: See page 34-35 for the complete range of aluminum extrusions.**

## INDOOR/OUTDOOR DIMMABLE DRIVERS

### TRE24L40DC

Max 7' (2.1m)  
Min 8 Watts, 1.5'(0.45m) LED High Efficacy  
6.77" x 2.67" x 1.26" (171 x 68 x 32mm)

### TRE24L96DC

Max 17.6' (5.3m)  
Min 8 Watts, 1.5'(0.45m) LED High Efficacy  
6.77" x 2.67" x 1.26" (171 x 68 x 32mm)

## NON DIMMABLE DRIVERS

### LEDDR-24-120W

Indoor/Outdoor driver  
Max 17.6 (5.3m) per single tap  
Max 23' (7m) combined 2 secondary taps  
Input: 100 - 240V AC  
Output: 24V DC  
10" x 3 3/8" x 3 3/16" (254 x 85.7 x 80.9mm)

# LED TAPE LIGHT COB, Indoor

Offers both performance and superior even illumination suitable for commercial, retail and residential applications.



## FEATURES

- 1 Bin
- 2 Step MacAdam Ellipse
- 3oz PCB board
- 3M Adhesive
- 50,000 hours life
- Field cuttable every 50mm (2")
- Low power consumption
- Smooth luminance - no hot spots
- Available in 20' (6.1m) and 100' (30.48m) spools (custom cuts available)
- 20' spools come with 6Ft pre-soldered power feeds
- Safe, 24V DC operation
- Fully dimmable with dimmable power supplies (sold separately)
- 6 years limited warranty

## APPLICATIONS

- Aisle and stairway lighting
- Cabinet and cove lighting
- Back lighting
- Showcase lighting
- Linear decorative lighting

## SPECIFICATIONS

Electrical	24V DC, 4.2W/FT
LED Type	High Brightness LEDs
Viewing Angle	120°
LED Life	50,000 hours
LED Spacing	2mm (0.08")
# of LEDs per foot	91
Maximum single run	20'
Custom cuttable	50mm (2")
Lumen Output	374 Lumens per ft 6500K 336 Lumens per ft 4000K 328 Lumens per ft 3500K 319 Lumens per ft 3000K 315 Lumens per ft 2700K
Efficacy	89 LPW 6500K, 80 LPW 4000K, 78 LPW 3500K, 76 LPW 3000K, 75 LPW 2700K
Color Temperature	2700K, 3000K, 3500K, 4000K, 6500K
CRI	>90 for white color temperatures
Approvals	cETLus

## PRODUCT CODES

20Ft spools

**LTP - 20 - YY - COB - H90**

LED Tape Light  
COB, Indoor

LED COLOR  
2700K  
3000K  
3500K  
4000K  
6500K

**LTP - 20 - YY - COB**

LED COLOR  
RD - Red  
AM - Amber  
GR - Green  
BL - Blue

100Ft spools

**LTP - 100 - YY - COB - H90**

LED Tape Light  
COB, Indoor

LED COLOR  
2700K  
3000K  
3500K  
4000K  
6500K

**LTP - 100 - YY - COB**

LED COLOR  
RD - Red  
AM - Amber  
GR - Green  
BL - Blue

Custom cuts

**LTP - XX - YY - COB - H90**

LED Tape Light  
COB, Indoor

LED COLOR  
2700K  
3000K  
3500K  
4000K  
6500K

**LTP - XX - YY - COB**

LED COLOR  
RD - Red  
AM - Amber  
GR - Green  
BL - Blue

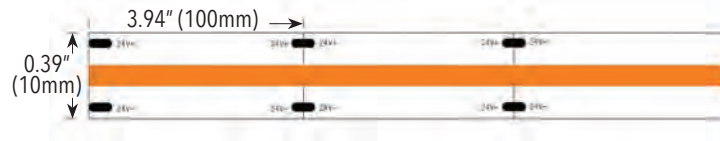

**ACCESSORIES**



**LTP-001-HD-HP-6**  
72" Power feed connector for high density indoor



**LMSII-001**  
Terminal block and junction box for connection to additional lengths of power cable if needed

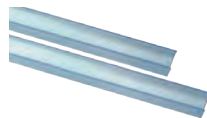

**LTP-010-S**  
Clear PVC mounting "U" channel



**LV-SPIR-1CH-LV**  
PIR Motion Sensor, 1 Channel, 24V DC  
NOTE: To be used with non dimmable drivers only

**NOTE: See page 34-35 for the complete range of aluminum extrusions.**

**INDOOR/OUTDOOR DIMMABLE DRIVERS**

**TRE24L40DC**  
Max 8.6' (2.6m)  
Min 8 Watts, 1.9'(0.57M) LED COB Tape  
6.77" x 2.67" x 1.26" (171 x 68 x 32mm)

**TRE24L96DC**  
Max 21.4' (6.5m)  
Min 8 Watts, 1.9'(0.57m) LED COB Tape  
6.77" x 2.67" x 1.26" (171 x 68 x 32mm)

**NON DIMMABLE DRIVERS**

**LEDDR-24-120W**  
Indoor/Outdoor driver  
Max 21.4' (6.5m) per single tap  
Max 28' (8.5m) combined 2 secondary taps  
Input: 100 - 240V AC  
Output: 24V DC  
10" x 3 3/8" x 3 3/16" (254 x 85.7 x 80.9mm)

# LED TAPE LIGHT

## Dim to Warm

Suitable for both hospitality and residential applications creating an inviting atmosphere.

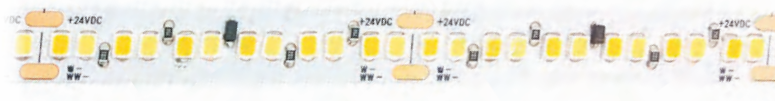

### FEATURES

- 1 Bin
- 2 Step MacAdam Ellipse
- 3oz PCB board
- 3M Adhesive
- 50,000 hours life
- Field cuttable every 50mm (2")
- Low power consumption
- Auto Warm-dim technology
- Available in 16' (5m) and 100' (30.48m) spools (custom cuts available)
- 16' spools come with 6Ft pre-soldered power feeds
- Safe, 24V DC operation
- Dim-to-warm: 1800K to 3000K
- No special controllers required
- 6 years limited warranty

### APPLICATIONS

- Aisle and stairway lighting
- Cabinet and cove lighting
- Back lighting
- Showcase lighting
- Linear decorative lighting

### PRODUCT CODES

16Ft spools  
LTP - 16 - WW - DIM - H90

100Ft spools  
LTP - 100 - WW - DIM - H90

Custom cuts  
LTP - XX - WW - DIM - H90

### SPECIFICATIONS

Electrical	24V DC, 5.5W/FT
LED Type	Epistar
Viewing Angle	120°
LED Life	50,000 hours
# of LEDs per foot	240
Maximum single run	16'
Custom cuttable	50mm (2")
Lumen Output	449LM/FT
Color Temperature	1800K-3000K
CRI	>90
Approvals	cETLus

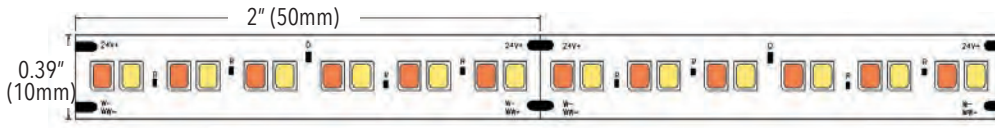

## ACCESSORIES



**LTP-001-HD-HP-6**  
72" Power feed connector for high density indoor



**LMSII-001**  
Terminal block and junction box for connection to additional lengths of power cable if needed

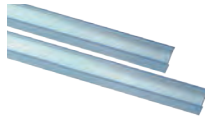

**LTP-010-S**  
Clear PVC mounting "U" channel

**NOTE: See page 34-35 for the complete range of aluminum extrusions.**

## INDOOR/OUTDOOR DIMMABLE DRIVERS

### TRE24L40DC

Max 6.5' (1.98m)  
Min 8 Watts, 1.45' (0.44m)  
6.77" x 2.67" x 1.26" (171 x 68 x 32mm)

### TRE24L96DC

Max 16' (5m)  
Min 8 Watts, 1.45' (0.44m)  
6.77" x 2.67" x 1.26" (171 x 68 x 32mm)

## LED TAPE LIGHT

# High Power RGB Indoor

Excellent choice for dynamic environments such as cinemas, retail and hospitality needing higher illumination.



## HIGH POWER RGB LTP-20-RGB SERIES



### FEATURES

- 50,000 hours life
- High brightness 5060 SMD LEDs
- Field cuttable
- Low power consumption
- Available in 20' (6.1m) and 100' (30.48m) spools (custom cuts available)
- 20' spools come with 6 ft. pre-soldered power feeds
- Safe, 24V class 2 power supplies (sold separately)
- Controllers sold separately
- 6 year limited warranty

### APPLICATIONS

- Aisle and stairway lighting
- Cabinet and cove lighting
- Back lighting
- Showcase lighting
- Linear decorative lighting

### PRODUCT CODES

20Ft spools  
LTP - 20 - RGB

100Ft spools  
LTP - 100 - RGB

Custom cuts  
LTP - XX - RGB

### SPECIFICATIONS

Electrical	24V DC, 4.3W/ft
LED Type	High Brightness 5060 SMD LEDs
Viewing Angle	120°
LED Life	50,000 hours to 70% initial lumen output
LED Spacing	16mm (0.63")
# of LEDs per foot (304mm)	18
Maximum Single Run	20'
Custom Cuttable	4"
Approvals	cETLus

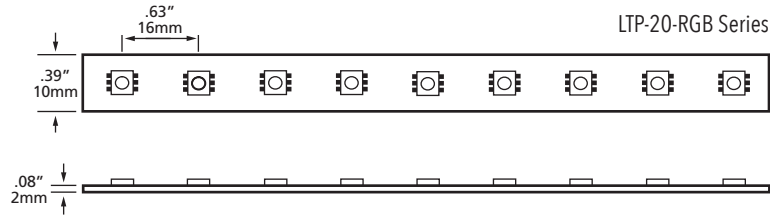

## ACCESSORIES



**LTP-001-RGB-6R**  
72" Power feed connector for RGB indoor. Add "L" for opposite end.



**LTP-002-RGB**  
In-line connector for RGB indoor



**LTP-001-RGB-6IN**  
6" In-line connector for RGB indoor  
**LTP-001-RGB-2IN**  
2" In-line connector for RGB indoor

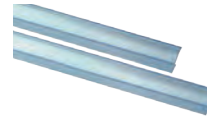

**LTP-010-S**  
Clear PVC mounting "U" channel



**LT-095-RF**  
6 Key RGB "touch" controller 12/24V DC



**LN-CON-WIFI-3CH-XV**  
WiFi controller for RGB, c/w RF remote 12/24VDC

**LT-390A**  
Signal amplifier for RGB

**NOTE: See page 34-35 for the complete range of aluminum extrusions.**

## NON DIMMABLE DRIVERS

### LEDDR-24-120W

Indoor/Outdoor driver  
Max. recommended load 90W or 20' (6.1m) per single tap, 120W or 27' (8.23m) combined two secondary taps.  
120W hardwire  
Input: 100 - 240V AC  
Output: 24V DC  
10" x 3 3/8" x 3 3/16" (254 x 85.7 x 80.9mm)



# LED TAPE LIGHT

## Low Power RGB Indoor

For more subtle approaches within entertainment venues and restaurants.



### LOW POWER RGB LTP-20-RGB-LP SERIES



#### FEATURES

- 50,000 hours life
- High brightness 5060 SMD LEDs
- Field cuttable
- Low power consumption
- Available in 20' (6.1m) and 100' (30.48m) spools (custom cuts available)
- 20' spools come with 6 ft. pre-soldered power feeds
- Safe, 24V class 2 power supplies (sold separately)
- 6 year limited warranty

#### APPLICATIONS

- Aisle and stairway lighting
- Cabinet and cove lighting
- Back lighting
- Showcase lighting
- Linear decorative lighting

#### PRODUCT CODES

20Ft spools  
LTP - 20 - RGB - LP

100Ft spools  
LTP - 100 - RGB - LP

Custom cuts  
LTP - XX - RGB - LP

#### SPECIFICATIONS

Electrical	24V DC, 2.2W/ft
LED Type	High Brightness 5060 SMD LEDs
Viewing Angle	120°
LED Life	50,000 hours to 70% initial lumen output
LED Spacing	32mm (1.26")
# of LEDs per foot (304mm)	9
Maximum Single Run	40'
Custom Cuttable	6.5"
Approvals	cETLus

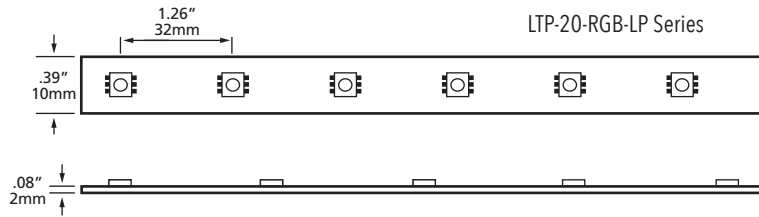

## ACCESSORIES



**LTP-001-RGB-6R**  
72" Power feed connector for RGB indoor. Add "L" for opposite end.



**LTP-002-RGB**  
In-line connector for RGB indoor



**LTP-001-RGB-6IN**  
6" In-line connector for RGB indoor  
**LTP-001-RGB-2IN**  
2" In-line connector for RGB indoor

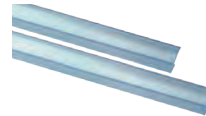

**LTP-010-S**  
Clear PVC mounting "U" channel



**LT-09S-RF**  
6 Key RGB "touch" controller 12/24V DC



**LN-CON-WIFI-3CH-XV**  
WiFi controller for RGB, c/w RF remote 12/24VDC



**LT-390A**  
Signal amplifier for RGB

**NOTE: See page 34-35 for the complete range of aluminum extrusions.**

## NON DIMMABLE DRIVERS

### LEDDR-24-120W

Indoor/Outdoor driver  
Max. recommended load 90W or 40' (12.1m) per single tap, 120W or 54' (16.46m) combined two secondary taps.  
120W hardwire  
Input: 100 - 240V AC  
Output: 24V DC  
10" x 3 3/8" x 3 3/16" (254 x 85.7 x 80.9mm)

# LED TAPE LIGHT

## High Power RGBW Indoor

Offers dynamic range of color and dedicated white for greater versatility suitable for all market segments.



### HIGH POWER RGB LTP-20-RGBW SERIES



#### FEATURES

- 50,000 hours life
- High brightness 5050 SMD LEDs
- Field cuttable
- Low power consumption
- Available in 20' (6.1m) and 100' (30.48m) spools (custom cuts available)
- RGB color change plus 3000K, 4000K and 6500K color temperatures
- 20' spools come with 6 ft. pre-soldered power feeds
- Safe, 24V class 2 power supplies (sold separately)
- 6 year limited warranty

#### APPLICATIONS

- Aisle and stairway lighting
- Cabinet and cove lighting
- Back lighting
- Showcase lighting
- Linear decorative lighting

#### PRODUCT CODES

20Ft spools

LTP - 20 - RGBYY - H90

**LED COLOR**

- 3000K
- 4000K
- 6500K

100Ft spools

LTP - 100 - RGBYY - H90

**LED COLOR**

- 3000K
- 4000K
- 6500K

Custom cuts

LTP - XX - RGBYY - H90

**LED COLOR**

- 3000K
- 4000K
- 6500K

#### SPECIFICATIONS

Electrical	24V DC, 4.3W/ft
LED Type	High Brightness 5050 SMD LEDs
Viewing Angle	120°
LED Life	50,000 hours to 70% initial lumen output
LED Spacing	16mm (0.63")
# of LEDs per foot (304mm)	18
Maximum Single Run	20'
Custom Cuttable	4"
CRI	>90 for white color temperatures
Approvals	cETLus

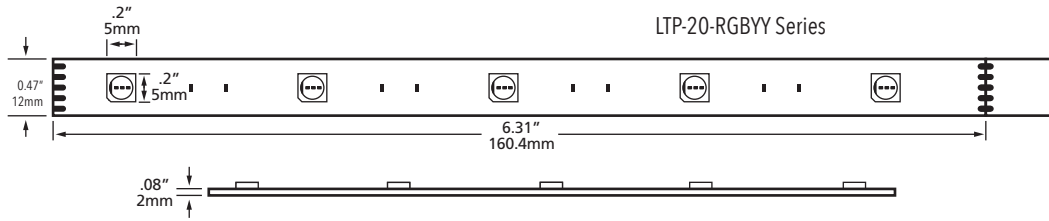

## ACCESSORIES



**LTP-001-RGBW-6**  
72" Power feed connector  
for RGBW indoor  
**LTP-001-RGBW-12**  
144" Power feed connector  
for RGBW indoor



**LTP-002-RGBW**  
In-line connector for RGBW  
indoor



**LTP-001-RGBW-6IN**  
6" In-line connector for  
RGBW indoor



**LT-115-RF**  
RGBW controller



**LT-490A**  
RGBW signal amplifier  
*NOTE: Network cable with  
RJ45 connectors required  
(not supplied)*

**NOTE: See page 34-35 for the complete range of aluminum extrusions.**

## NON DIMMABLE DRIVERS

### LEDDR-24-120W

Indoor/Outdoor driver  
Max. recommended load 90W or 20' (6.1m) per single tap,  
120W or 27' (8.23m) combined two secondary taps.  
120W hardwire  
Input: 100 - 240V AC  
Output: 24V DC  
10" x 3 3/8" x 3 3/16" (254 x 85.7 x 80.9mm)

# LED TAPE LIGHT CCT Indoor

Where applications demand a greater dynamic range within the White Light Spectrum. Hospitality, retail, residential and commercial.



## CCT COLOR TEMP ADJUST SERIES



### FEATURES

- 50,000 hours life
- High brightness 3528 SMD LEDs
- Field cuttable
- Low power consumption
- Available in 16' (5M) spools
- 16' spools come with 6 ft. pre-soldered power feeds
- Safe, 24V class 2 power supplies (sold separately)
- Controller sold separately
- 6 year limited warranty

### APPLICATIONS

- Aisle and stairway lighting
- Cabinet and cove lighting
- Back lighting
- Showcase lighting
- Linear decorative lighting

### PRODUCT CODES

LTP - 16 - CCT - H90

### SPECIFICATIONS

Electrical	24V DC, 5.8W/ft
LED Type	High Brightness 3528 SMD LEDs
Viewing Angle	120°
LED Life	50,000 hours to 70% initial lumen output
LED Spacing	8.3mm (0.33")
# of LEDs per foot (304mm)	36
Maximum Single Run	16'
Lumen Output	383 Lumens per ft 7000K 261 Lumens per ft 3000K
Efficacy	66LPW 7000K 45LPW 3000K
Color Temperature	2500K-7000K
Custom Cuttable	2"
CRI	> 90
Approvals	cETLus

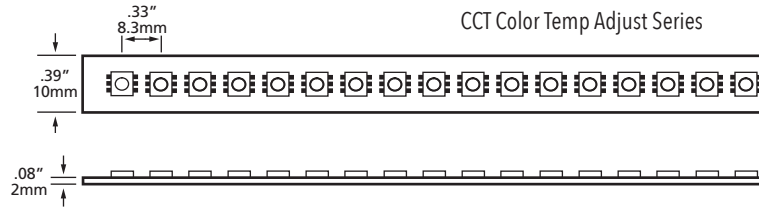

## ACCESSORIES



**LTP-001-CCT-6**  
72" Power feed connector for CCT indoor. Add "-O" for opposite end.



**LTP-002-CCT**  
In-line connector for CCT series indoor



**LTP-001-CCT-6IN**  
6" (15cm) in line connector

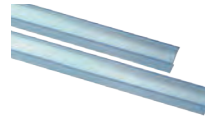

**LTP-010-S**  
Clear PVC mounting "U" channel



**LT-031-RF**  
6 Key CCT Adjustable "touch" controller 12/24V DC



**LT-290A**  
CCT signal amplifier

**NOTE:** See page 34-35 for the complete range of aluminum extrusions.

## NON DIMMABLE DRIVERS

### LEDDR-24-120W

Indoor/Outdoor driver  
16' (4.88m) per single tap, 20' (6.1m) combined two secondary taps.  
120W hardwire  
Input: 100 - 240V AC  
Output: 24V DC  
10" x 3 3/8" x 3 3/16" (254 x 85.7 x 80.9mm)

# LED TAPE LIGHT

## High Power Outdoor

Exterior rated suitable for those commercial, retail and hospitality applications requiring higher illumination.



### HIGH POWER SINGLE COLOR LTP-OD SERIES



#### FEATURES

- 1 Bin
- 2 Step MacAdam Ellipse
- 3oz PCB board
- 3M Adhesive
- 50,000 hours life
- High brightness 5060 SMD LEDs
- Field cuttable
- Low power consumption
- Available in 20' (6.1m) spools
- Safe, 24V class 2 power supplies (sold separately)
- Fully dimmable with dimmable power supplies (sold separately)
- 6 year limited warranty

#### APPLICATIONS

- Aisle and stairway lighting
- Cabinet and cove lighting
- Back lighting
- Showcase lighting
- Linear decorative lighting

#### PRODUCT CODES

LTP - OD - 20 - **YY** - H90

#### LED COLOR

- 2700K
- 3000K
- 3500K
- 4000K
- 6500K

#### SPECIFICATIONS

Electrical	24V DC, 4.3W/ft
LED Type	High Brightness 5060 SMD LEDs
Viewing Angle	120°
LED Life	50,000 hours to 70% initial lumen output
LED Spacing	16mm (0.63")
# of LEDs per foot (304mm)	18
Maximum Single Run	20'
Custom Cuttable	4"
Lumen Output	325 Lumens per ft 6500K 300 Lumens per ft 4000K 293 Lumens per ft 3500K 285 Lumens per ft 3000K 280 Lumens per ft 2700K
Efficacy	75 LPW 6500K, 70 LPW 4000K, 68 LPW 3500K, 66 LPW 3000K, 65 LPW 2700K
Color Temperature	2700K, 3000K, 3500K, 4000K, 6500K
CRI	> 90
Approvals	cETLus

NOTE: Outdoor Tape Light comes with liquid-tight connectors pre-installed on both ends, so it is necessary to make the cuts starting from extremities. Cut pieces can be terminated, but not joined together.

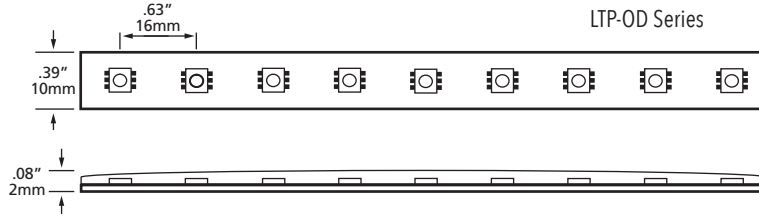

## ACCESSORIES



**LTP-001-OD-6FT**  
72" Power feed connector  
for single color outdoor



**LV-FS-MC-004**  
Mounting clips

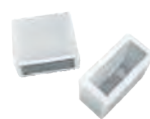

**LV-FS-EC-001**  
End caps

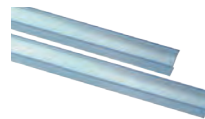

**LTP-010-5**  
Clear PVC mounting  
"U" channel

**NOTE:** See page 34-35 for the complete range of aluminum extrusions.

## INDOOR/OUTDOOR DIMMABLE DRIVERS

### TRE24L40DC

Max recommended load 36W or 8' LED Tape,  
min 8W or 2' LED Tape  
6.77" x 2.67" x 1.26" (171 x 68 x 32mm)

### TRE24L96DC

Max recommended load 90W or 20' LED Tape,  
min 8W or 2' LED Tape  
6.77" x 2.67" x 1.26" (171 x 68 x 32mm)

NOTE: For outdoor installations, please add E-KO-SR strain relief (2pcs/driver).

## NON DIMMABLE DRIVERS

### LEDDR-24-120W

Indoor/Outdoor driver  
Max. recommended load 90W or 20' (6.1m) per single tap,  
120W or 27' (8.23m) combined two secondary taps.  
120W hardwire  
Input: 100 - 240V AC  
Output: 24V DC  
10" x 3 3/8" x 3 3/16" (254 x 85.7 x 80.9mm)



# LED TAPE LIGHT

## Low Power Outdoor

This exterior rated tape offers more subtle illumination approach for commercial, hospitality and residential use.



### LOW POWER SINGLE COLOR LTP-OD-LP SERIES



#### FEATURES

- 1 Bin
- 2 Step MacAdam Ellipse
- 3oz PCB board
- 3M Adhesive
- 50,000 hours life
- High brightness 5060 SMD LEDs
- Field cuttable
- Low power consumption
- Available in 20' (6.1m) spools
- Safe, 24V class 2 power supplies (sold separately)
- Fully dimmable with dimmable power supplies (sold separately)
- 6 year limited warranty

#### APPLICATIONS

- Aisle and stairway lighting
- Cabinet and cove lighting
- Back lighting
- Showcase lighting
- Linear decorative lighting

#### PRODUCT CODES

LTP - OD - 20 - **YY** - LP - H90

#### LED COLOR

- 2700K
- 3000K
- 3500K
- 4000K
- 6500K

#### SPECIFICATIONS

Electrical	24V DC, 2.2W/ft
LED Type	High Brightness 5060 SMD LEDs
Viewing Angle	120°
LED Life	50,000 hours to 70% initial lumen output
LED Spacing	32mm (1.26")
# of LEDs per foot (304mm)	9
Maximum Single Run	40'
Custom Cuttable	6.5"
Lumen Output	165 Lumens per ft 6500K 150 Lumens per ft 4000K 148 Lumens per ft 3500K 145 Lumens per ft 3000K 143 Lumens per ft 2700K
Efficacy	75 LPW 6500K, 68 LPW 4000K, 67 LPW 3500K, 66 LPW 3000K, 65 LPW 2700K
Color Temperature	2700K, 3000K, 3500K, 4000K, 6500K
CRI	> 90
Approvals	cETLus

NOTE: Outdoor Tape Light comes with liquid-tight connectors pre-installed on both ends, so it is necessary to make the cuts starting from extremities. Cut pieces can be terminated, but not joined together.

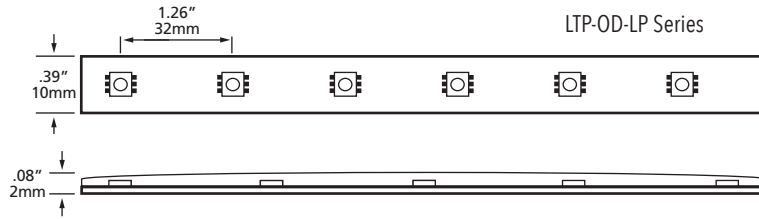

## ACCESSORIES



**LTP-001-OD-6FT**  
72" Power feed connector  
for single color outdoor



**LV-FS-MC-004**  
Mounting clips

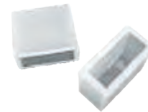

**LV-FS-EC-001**  
End caps

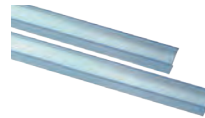

**LTP-010-S**  
Clear PVC mounting  
"U" channel

**NOTE: See page 34-35 for the complete range of aluminum extrusions.**

## INDOOR/OUTDOOR DIMMABLE DRIVERS

### TRE24L40DC

Max recommended load 36W or 16' LED Tape,  
min 8W or 2' LED Tape  
6.77" x 2.67" x 1.26" (171 x 68 x 32mm)

### TRE24L96DC

Max recommended load 90W or 40' LED Tape,  
min 8W or 2' LED Tape  
6.77" x 2.67" x 1.26" (171 x 68 x 32mm)

NOTE: For outdoor installations, please add E-KO-SR strain relief (2pcs/driver).

## NON DIMMABLE DRIVERS

### LEDDR-24-120W

Indoor/Outdoor driver  
Max. recommended load 90W or 40' (12.1m) per single tap,  
120W or 54' (16.46m) combined two secondary taps.  
120W hardwire  
Input: 100 - 240V AC  
Output: 24V DC  
10" x 3 3/8" x 3 3/16" (254 x 85.7 x 80.9mm)

# LED TAPE LIGHT

## High Power RGB Outdoor

Great for enhancing outdoor spaces with a dynamic look. Suitable for hospitality, retail and commercial environments.



### HIGH POWER RGB OUTDOOR LTP-OD-RGB SERIES



#### FEATURES

- 50,000 hours life
- High brightness 5060 SMD LEDs
- Field cuttable
- Low power consumption
- Available in 20' (6.1m) spools
- Safe, 24V class 2 power supplies (sold separately)
- 6 year limited warranty

#### APPLICATIONS

- Aisle and stairway lighting
- Cabinet and cove lighting
- Back lighting
- Showcase lighting
- Linear decorative lighting

#### PRODUCT CODES

LTP - OD - 20 - RGB

#### SPECIFICATIONS

Electrical	24V DC, 4.3W/ft
LED Type	High Brightness 5060 SMD LEDs
Viewing Angle	120°
LED Life	50,000 hours to 70% initial lumen output
LED Spacing	16mm (0.63")
# of LEDs per foot (304mm)	18
Maximum Single Run	20'
Custom Cuttable	4"
Approvals	cETLus

NOTE: Outdoor Tape Light comes with liquid-tight connectors pre-installed on both ends, so it is necessary to make the cuts starting from extremities. Cut pieces can be terminated, but not joined together.

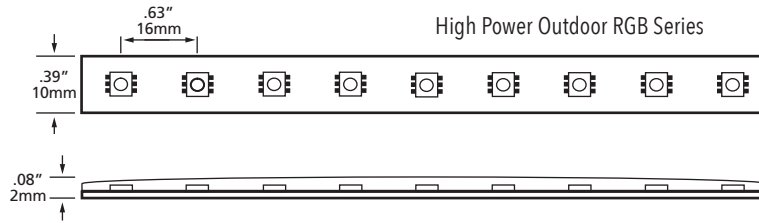

## ACCESSORIES



**LTP-RGB-001-OD-6FT**  
72" Power feed connector  
for RGB outdoor



**LV-FS-MC-004**  
Mounting clips

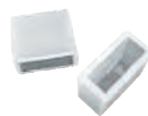

**LV-FS-EC-001**  
End caps

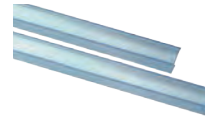

**LTP-010-S**  
Clear PVC mounting  
"U" channel



**LT-09S-RF**  
6 Key RGB "touch" controller  
12/24V DC



**LN-CON-WIFI-3CH-XV**  
WiFi controller for RGB,  
c/w RF remote 12/24VDC



**LV-ZJFFS-3CH-6INW**  
Outdoor RGB signal  
amplifier

**NOTE: See page 34-35 for the complete range of aluminum extrusions.**

## NON DIMMABLE DRIVERS

### LEDDR-24-120W

Indoor/Outdoor driver  
Max. recommended load 90W or 20' (6.1m) per single tap,  
120W or 27' (8.23m) combined two secondary taps.  
120W hardwire  
Input: 100 - 240V AC  
Output: 24V DC  
10" x 3 3/8" x 3 3/16" (254 x 85.7 x 80.9mm)

# LED TAPE LIGHT

## Low Power RGB Outdoor

For those exterior applications requiring a dynamic but subtle approach. Suitable for residential, hospitality, commercial and retail.



### LOW POWER RGB LTP-OD-RGB-LP SERIES



#### FEATURES

- 50,000 hours life
- High brightness 5060 SMD LEDs
- Field cuttable
- Low power consumption
- Available in 20' (6.1m) spools
- Safe, 24V class 2 power supplies (sold separately)
- 6 year limited warranty

#### APPLICATIONS

- Aisle and stairway lighting
- Cabinet and cove lighting
- Back lighting
- Showcase lighting
- Linear decorative lighting

#### PRODUCT CODES

LTP - OD - 20 - RGB - LP

#### SPECIFICATIONS

Electrical	24V DC, 2.2 W/ft
LED Type	High Brightness 5060 SMD LEDs
Viewing Angle	120°
LED Life	50,000 hours to 70% initial lumen output
LED Spacing	32mm (1.26")
# of LEDs per foot (304mm)	9
Maximum Single Run	40'
Custom Cuttable	6.5"
Approvals	cETLus

NOTE: Outdoor Tape Light comes with liquid-tight connectors pre-installed on both ends, so it is necessary to make the cuts starting from extremities. Cut pieces can be terminated, but not joined together.

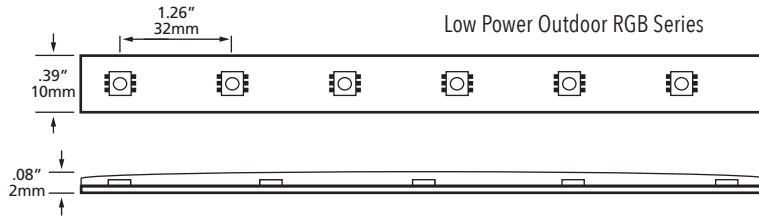

## ACCESSORIES



**LTP-RGB-001-OD-6FT**  
72" Power feed connector  
for RGB outdoor



**LV-FS-MC-004**  
Mounting clips

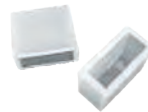

**LV-FS-EC-001**  
End caps

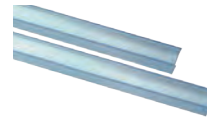

**LTP-010-S**  
Clear PVC mounting  
"U" channel



**LT-09S-RF**  
6 Key RGB "touch" controller  
12/24V DC



**LN-CON-WIFI-3CH-XV**  
WiFi controller for RGB,  
c/w RF remote 12/24VDC



**LV-ZJFFS-3CH-6INW**  
Outdoor RGB signal  
amplifier

**NOTE: See page 34-35 for the complete range of aluminum extrusions.**

## NON DIMMABLE DRIVERS

### LEDDR-24-120W

Indoor/Outdoor driver  
Max. recommended load 90W or 40' (12.1m) per single tap,  
120W or 54' (16.46m) combined two secondary taps.  
120W hardwire  
Input: 100 - 240V AC  
Output: 24V DC  
10" x 3 3/8" x 3 3/16" (254 x 85.7 x 80.9mm)

# LED Tape Light Extrusions

## LV-LB-D3-FR

Surface mount aluminum extrusion and frosted PC cover



### End Caps

LV-D1/D3-EC (2/bag)  
LV-D1/D3-EC-WF (2/bag)

### Mounting Clips

LV-D1/D3-MC (6/bag)

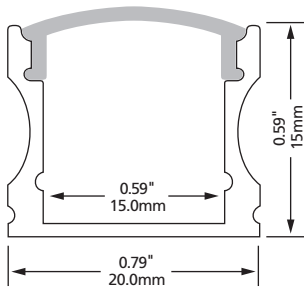

NOTE: available in 1M (39") and 2M (78") lengths.

## LV-ALP2208

Surface mount aluminum extrusion and frosted PC cover



### End Caps

LV-ALP2208-EC (2/bag)  
LV-ALP2208-EC-WF (2/bag)

### Mounting Clips

LV-ALP2208-MC (2/bag)

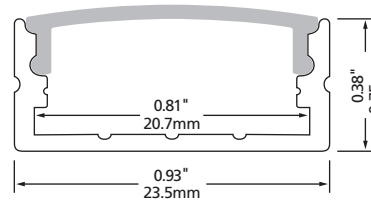

NOTE: available in 1M (39") lengths.

## LV-ALP007

Surface mount aluminum extrusion and frosted PC cover



### End Caps

LV-ALP007-EC (2/bag)  
LV-ALP007-EC-WF (2/bag)

### Mounting Clips

LV-ALP007-MC (6/bag)

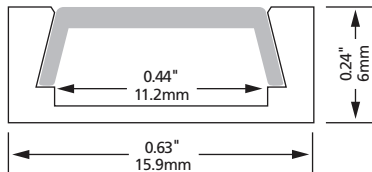

NOTE: available in 1M (39") and 2M (78") lengths.

## LV-LB-V3-FR

Corner surface mounted aluminum extrusion and frosted PC cover

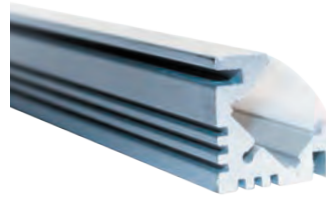

### End Caps

LV-V1/V3-EC (2/bag)  
LV-V1/V3-EC-WF (2/bag)

### Mounting Clips

LV-V1/V3-MC (6/bag)

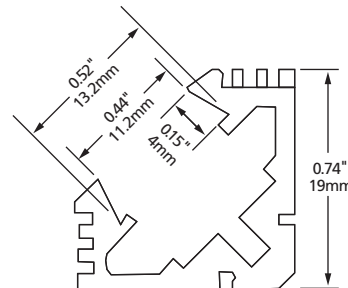

NOTE: available in 1M (39") lengths.

**LV-LB-W3-FR**

Recessed aluminum extrusion and frosted PC cover



**End Caps**

LV-W1/W3-EC (2/bag)  
LV-W1/W3-EC-WF (2/bag)

**Mounting Clips**

LV-W1/W3-MC (6/bag)

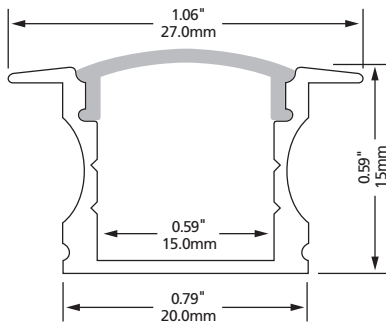

NOTE: available in 1M (39") lengths.

**LV-ALP2908**

Recessed aluminum extrusion and frosted PC cover



**End Caps**

LV-ALP2908-EC (2/bag)  
LV-ALP2908-EC-WF (2/bag)

**Mounting Clips**

LV-ALP2908-MC (2/bag)

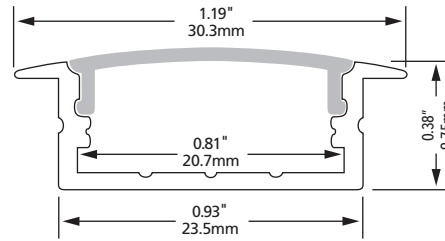

NOTE: available in 1M (39") lengths.

**LV-1401**

Closet aluminum extrusion with mounting brackets and frosted PC cover

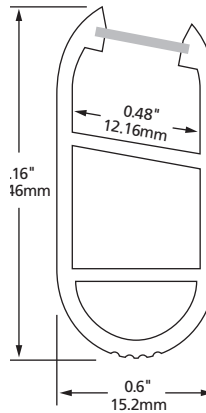

1M (39") extrusion ships complete with two mounting end caps and one support bracket